

EVALUATION OF THE RESPONSE TIME OF AIR GAUGES IN INDUSTRIAL APPLICATIONS

Czesław Janusz Jermak, Mirosław Rucki

*Poznan University of Technology, Institute of Mechanical Technology, Pl. M. Skłodowskiej-Curie 5, 60-965 Poznań, Poland
(cz.jermak@interia.pl, miroslaw.rucki@put.poznan.pl, +48 61 665 3568)*

Abstract

The goal of the investigations was to evaluate the dynamical properties of air gauges in order to exploit them in such industrial applications as in-process control, form deviation measurement, dynamical measurement. As an important parameter, the time response was analyzed theoretically and experiments were performed in order to verify the proposed calculation model. The analyzed air gauges were applied in the devices for non-contact measurement of roundness and cylindricity, as well as in the contour and waviness measurement device. Because of evident physical conditions of experiments, the input signal should not be treated as an orthogonal step, but as a quasi-trapezoidal step which could be approximated in simulations as a trapezoidal one. The time response indicates that the air gauges with small measuring chambers should be treated as first-order dynamic systems.

Keywords: response time, air gauges, dimensional measurement, in-process control.

© 2009 Polish Academy of Sciences. All rights reserved

1. Introduction

After a decade of some decline in air gauge application, they are again delivered by most of the measuring tool producers, and again they became a subject of scientific interest [1]. The dynamical properties of air gauges are important for metrology, because they are applied in systems of in-process control (dynamical measurement) [2] and in measuring automatons (quick measurement) [3]. Recently, some of companies offer pneumatic devices for non-contact measurement of form deviations like runout, roundness, straightness and so on. Such a measurement deals with the input signal changing in time. In such conditions, perfect reproduction of the input signal is not possible and some dynamic error is inevitable.

Typical air gauges with large measuring chambers (several hundreds of cm³) present dynamic characteristics with a step response time of tens of seconds [4]. An additional problem is with the inner volume of the pressure sensing part which has its own inertia and delay time [5]. Nowadays, however, innovative air gauges have their measuring chamber volumes reduced, and the sensing part consists of piezoresistive pressure transducers built into the measuring chamber [6]. Because of the very small inner volume of the piezoresistive transducers and their short response time (according to [7], ca. 0.1 ms), such a solution definitely improves the dynamic characteristics of the air gauge. Instead of tens of seconds, the time constant of the air gauge could reach down the value of 0.002-0.025 s, dependent on the configurations of the air gauges (diameters of the inlet and measuring nozzles) and on the measuring chamber volume [8]. Such kind of air gauges with minimized measuring chambers and reduced sensing part volume are the subject of the present study.

2. Industrial applications

Advances in the capability and cost-effectiveness of computer equipment mean that information within measuring systems is generally processed by computer equipment and analyzed and designed by standard information technology methods. Measurement science has thus become closely associated with computer, information, control and systems science [9]. The non-contact measurement with air gauges in dynamic conditions takes place in the various devices for form deviation and waviness analysis. In Fig. 1, there is an example of the measurement with a Hommel Etamic probing head (a) and a presentation of the results (b) after computer data processing, like eccentricity and roundness deviation. Proper dynamic characteristics of the applied air gauge should ensure an acceptably low level of dynamic error of measurement.

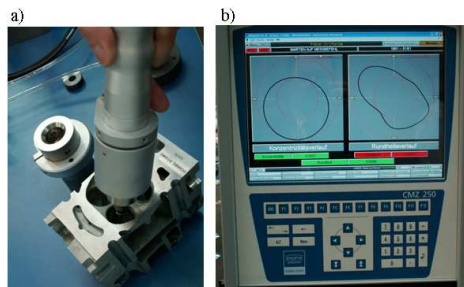

Fig. 1. Example of roundness measurement with a Hommel Etamic probing head (a) and a presentation of the results (b).

In other applications the linear profile underwent measurement with an air gauge, and here too, dynamic properties of the gauge could affect the results of measurement. At present, in the Division of Metrology and Measurement System (Poznan University of Technology) investigations are directed to solve a problem of non-contact measurement for the wood industry. For that purpose, a typical air gauge is placed into the frame shown in Fig. 2. The movement of the air gauge over the measured surface is being controlled by an external computer which simultaneously registers the measuring signal correlated with the position of the gauge. The device could be also equipped with an autonomous microprocessor and work independently, with the option of subsequent data transmission to the Quality Control System. At present, the device is under metrological tests and accuracy analysis.



Fig. 2. Air gauge in the scanning device for contour and waviness measurement.

An example of roughness measurement with the pneumatic device is shown in Fig. 3. The set of roughness standards with known Ra parameter underwent the roughness measurement

with an air gauge, as well as with a typical Perthen S8P roughness measurement device. The results of reference measurement with Perthen S8P are presented in Fig. 4.

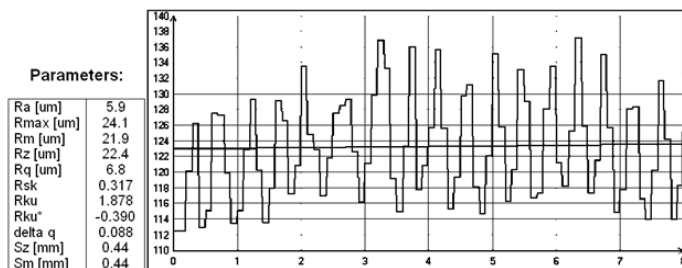

Fig. 3. Report on measurement of roughness standard (Ra=6.3) with a pneumatic device [10].

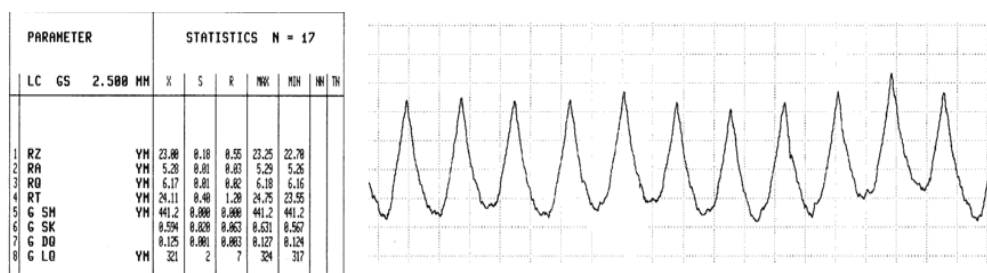

Fig. 4. Results for the same roughness standard obtained from Perthen S8P [10].

The profile obtained from the pneumatic device had a too large sampling step (0.1 s) that caused inaccurate repeatability. Nevertheless, the values of main parameters do not differ too much. During the measurement of a wooden surface, the sampling frequency was 15.625 Hz, which combined with linear movement of the stylus as small as 12 μm/s enabled a proper record and interpretation of the obtained profile [10].

Similarly, air gauges are the sensing elements in non-contact profile measurement in the motor industry. Fig. 5 presents an example of such a measurement. Here, the measuring head is equipped with a small motor which moves the air gauge along the measured profile. As a result, a profile is obtained which is the basis for calculation of non-linearity. The results are presented both as a graph and as numbers and may be further processed by the computer.

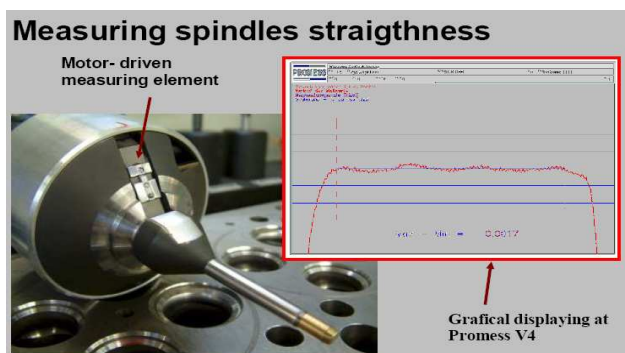

Fig. 5. Profile linearity measurement [11].

3. Experimental setup

In all the above mentioned applications, the dynamical properties of the air gauges are the crucial issue. To examine the dynamic behavior of a measurement system, several standard input signals are used, like Dirac's pulse $\delta(t)$, unit step function ($1(t)$ – sudden change of the input signal from zero to maximal value), linear rising function, orthogonal step function or sine input [12]. The sine input is considered the most easy to generate, so it is commonly used [13]. There are also some nontypical input signals applied in order to emphasize a chosen criterion of the dynamic error [14]. However, in most cases the sine or step input signal is being applied [15].

The investigations on the sine function response were described in [8], but an initial analysis of the step responses of air gauges [16] revealed that the air gauge dynamics depends on the actual pressure in the measuring chamber. Moreover, the falling pressure in the chambers generated a different time constant than a rising one, which is not deductible in the sine input investigations. Thus, additional investigations on the step response seemed to be needed.

Models of the air gauge with exchangeable inlet (d_w) and outlet (d_p) nozzles were prepared for the investigations in order to obtain various sensitivities and measuring ranges of the examined gauges. Investigations on the dynamic characteristics of the air gauges have been performed with the following equipment shown in Fig 6, specially designed to generate the step input signal [17]. Fed with the pressure p_z , the air gauge is placed in front of the moving table with a step height of Δs . It is sensitive to the changes of the slot width s , and responses with changes of the back-pressure p_k . When the table moves rapidly, it causes a quick change of the slot width s and causes a fall or rise of the back-pressure p_k , dependent on the direction of movement. The registered responses underwent processing.

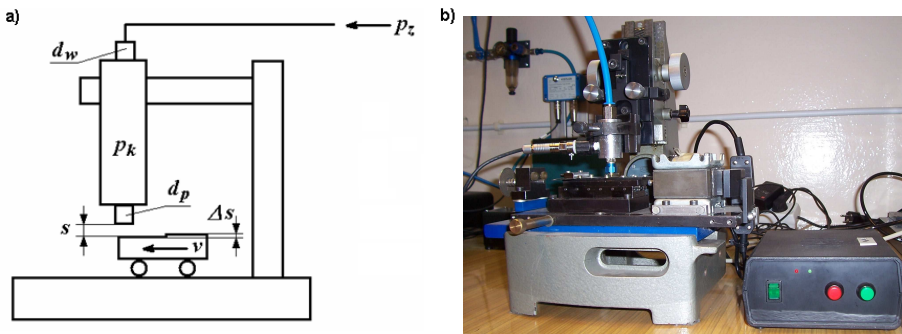

Fig. 6. The experimental setup for step response investigations: a) scheme, b) view [17].

In fact, the step change of the slot width does not generate a step change of the input signal, and therefore it is impossible to apply the typical evaluation method based on a step response graph [18]. Because of the limited velocity of the moving table ($v=2$ m/s), the input signal is rather a trapezoidal than step function. It could be seen in Fig. 7, where the initial (smaller) slot width is marked s_p , the final one s_k , and the distance between the inner edge of the measuring nozzle projected to the flapper surface and the edge of the step is marked x . Lengths l_k and l_p mean the lengths of the circle parts corresponding with the final slot s_k and the initial one s_p respectively.

In this way, the side cylinder surface which is the air outflow surface in that experiment, should be calculated as follows:

$$A = A_p + A_k = l_p s_p + l_k s_k. \quad (1)$$

Knowing that:

- $l_p + l_k = \pi d_p$;
- $A_p = (\pi d_p - l_k) s_p$

it could be written in another way:

$$A = (\pi d_p - l_k) s_p + l_k s_k. \quad (2)$$

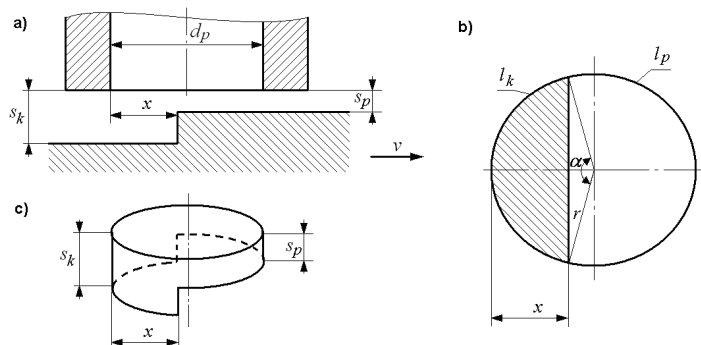

Fig. 7. Area between the measuring nozzle and the flapper surface with the step: a) profile view, b) top view, c) 3D view.

Here, the relation between the final circle part length l_k and the outflow surface A is described. Taking the following relations into consideration:

- $r = d_p / 2$;
- $x = r(1 - \cos \frac{\alpha}{2})$;
- $\alpha = 2 \arccos(1 - 2 \frac{x}{d_p})$

it could be obviously written:

$$l_k = \alpha \cdot r = \alpha \frac{d_p}{2} \quad (3)$$

or

$$l_k = d_p \arccos(1 - 2 \frac{x}{d_p}). \quad (4)$$

Hence, putting the last relation into formula (2), it could be written:

$$A = d_p [\pi s_p + (s_k - s_p) \arccos \left(1 - \frac{2x}{d_p} \right)]. \quad (5)$$

From formula (5) the values of actual outflow surface A can be calculated for each displacement x (Fig. 8a) or time (Fig. 8b). In Fig. 8, there are graphs of the surface A calculated for the air gauge with a measuring nozzle $d_p = 1.200$ mm, moving table velocity $v = 2$ m/s, and $s_p = 0.061$ mm, $s_k = 0.183$ mm.

In that case, the distance x will be passed by the moving table in time $t = 0.6$ ms, and that is the time when the initial slot s_p is fully replaced by the final slot s_k , and the outflow surface becomes A_k instead of A_p . The analysis proved that such a signal could be successfully treated

as a trapezoidal one, because the non-linearity $\delta_{nl} = \frac{|\Delta A - \Delta A_{lin}|_{max}}{\Delta A_{max}} \times 100\%$ is smaller than 10%

in any configuration of the air gauge. Fig. 8c shows the difference between ΔA (change of the outlet surface A during the experiment) and its linear value ΔA_{lin} , which should be generated for a trapezoidal input signal. In order to compare the behavior of the various nozzle diameters, the displacement $2x$ in the graphs is related to its maximal value d_p .

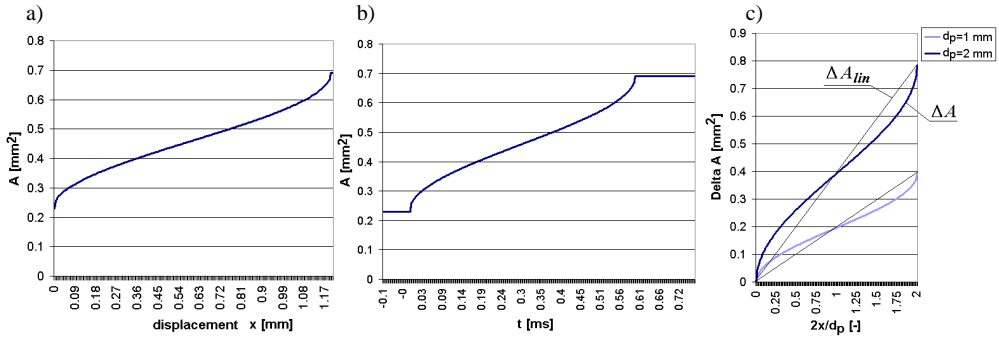

Fig. 8. Graphs of the outflow surface A dependent on: a) displacement x , b) time t ; c) graphs of the outflow surface ΔA for different measuring nozzles d_p .

4. Approximation of the trapezoidal step response

A quasi-trapezoidal step input generates a response of the air gauge in terms of time. Fig. 9 presents the registered pressure changes in the measuring chamber of the gauge with a measuring nozzle $d_p=1.200$ mm, inlet nozzle $d_w=1.000$ mm and the model measuring chamber of length $l=20$ mm and diameter $d=8$ mm. The graph deals with the table movement direction shown in Fig. 7, which causes the increase of the slot width and the fall of back-pressure p_k from 142.50 kPa down to 48.10 kPa.

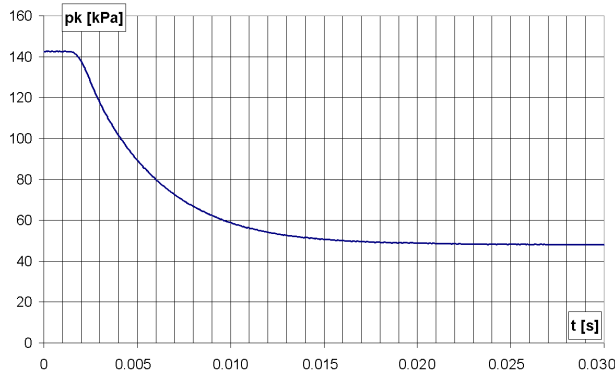

Fig. 9. Registered air gauge response to the quasi-trapezoidal input.

In order to approximate this kind of response, the algorithm proposed by Findeisen [19] was implemented. It assumes that the response $h(t)$ could be calculated step by step from the formula:

$$h(t) = x(t) + h(t - t_1), \quad (6)$$

where t_l is the rising time of input value.

Before t reaches the value of t_l , the functions $x(t)$ and $h(t)$ are identical. For the next points, to the function $x(t)$ the values of h taken from previous time moments should be added. When the input signal is a trapezoidal step, the relation between the functions $x(t)$ and $h(t)$ is following:

$$x(t) = \frac{1}{t_l} \left[\int_0^t h(\tau) d\tau - \int_0^{t-t_l} h(\tau) d\tau \right] \quad (7)$$

and, hence:

$$\frac{dx}{dt} = \frac{1}{t_l} [h(t) - h(t - t_l)]. \quad (8)$$

That means that the differential of the received function $x(t)$ has identical properties like an orthogonal step response function with the same height and lasting for t_l . Hence, it is possible to calculate it from formula (6). The result of the approximation with the above algorithm is presented in Fig. 10. The investigated air gauge is the same as in the case of Fig. 9, but the response is represented as $h(t)$.

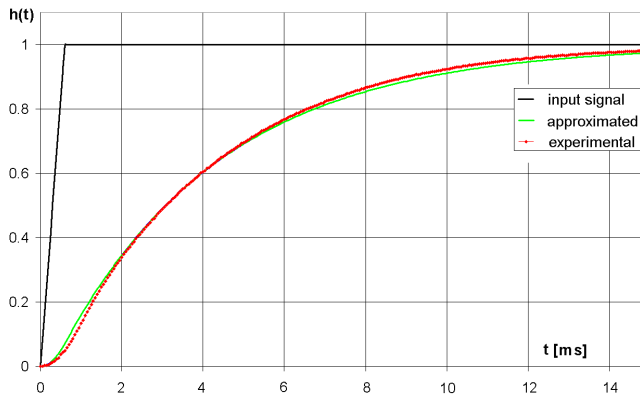

Fig. 10. Graphs of the simulated and experimental trapezoidal step response of the air gauge.

It is seen that the difference between the approximated and experimental functions of a trapezoidal step response is small (ca. 3%) and appears mainly in the first two milliseconds. The largest values of the differences lie in the area of $h(t)$ close to 0.1 and 0.9 which corresponds with the maximal non-linearity of the quasi-trapezoidal signal δ_{nl} (Fig. 8c). The determined response time was $T=4$ ms. The experiments and simulations proved that after the input signal is considered as a quasi-trapezoidal one, the air gauge with a small measuring chamber could be treated as a first-order dynamic system.

5. Falling and rising pressure

Since the measuring chamber in dynamic conditions is being filled through the inlet nozzle d_w and emptied through the flapper nozzle area determined by the measuring nozzle d_p and the slot width s , it should be expected that the falling and rising pressure would reveal different dynamic properties. Indeed, such results were obtained and presented in Fig. 11. In order to emphasize the difference, both responses are represented as $h(t)$. Approximated time constants are $T=0.030$ s for the rising pressure and $T=0.023$ s for the falling one with an error of 10%.

Calculated as 1/3 of the setting time, the time constant would be 0.025 and 0.017 s respectively. These results indicate the need of better approximation of the step response.

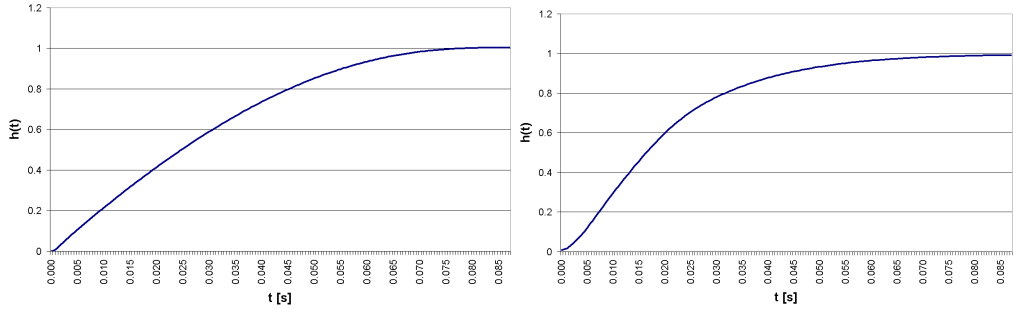

Fig. 11. Time responses of an air gauge with $d_p = 1.2$ and $d_w = 0.7$ mm for rising (left) and falling (right) back-pressure.

Moreover, study on the flow-through models have led to the conclusion that the process of emptying of the vessel with pressured gas does not run with the same time constant, but its value depends on the pressures relationship [20]:

$$T = \frac{1}{K} \left(1 - \frac{p_a}{p_0} \right), \quad (9)$$

where:

- K – factor of proportionality;
- p_a, p_0 – atmospheric pressure and initial pressure in the vessel, respectively.

It was proved experimentally that the time constant was pressure-dependent and became smaller with pressures closer to the atmospheric pressure, in subsequent moments of time.

Taking that into consideration, as well as based on the proved first-order response, a new series of approximations was performed. Still using the function:

$$y(t) = KA(1 - e^{-t/T}) \quad (10)$$

the values of time constant T were recalculated for each subsequent moment according to the actual back-pressure, and treating the initial period of few milliseconds as the time when the trapezoidal step is rising. Fig. 12 presents the obtained results for falling pressure. In that case, the change of the time constant is small (within 1 ms) so it could be omitted, and T could be assumed $T = 16.8$ ms for every value of p_k .

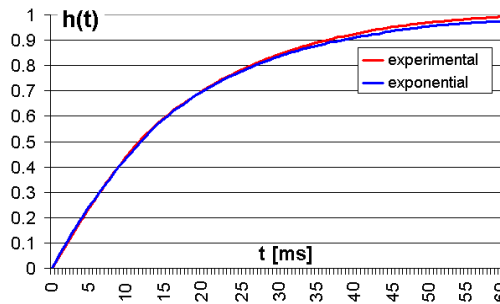

Fig. 12. Approximation of time response of an air gauge for falling back-pressure.

On the other hand, the dynamics of rising pressure is much more dependent on the actual back-pressure p_k , as seen in Fig. 13.

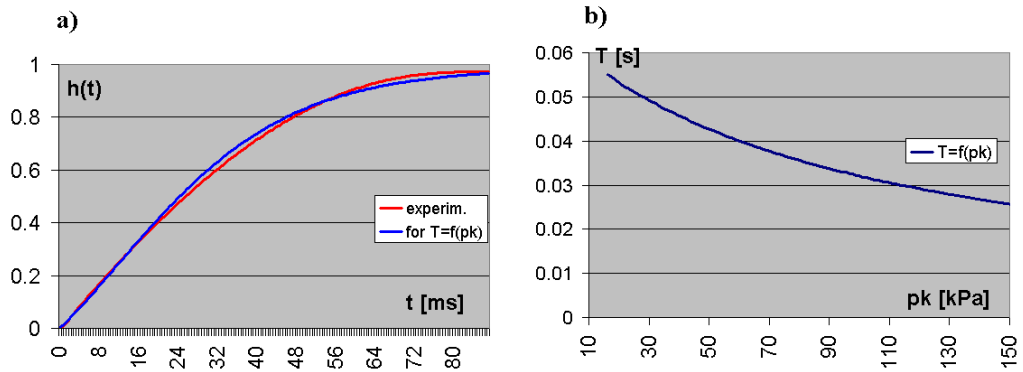

Fig. 13. Approximation of time response of an air gauge for rising back-pressure.

Approximation of time response shown in Fig. 13 with back-pressure dependent time constant $T = f(p_k)$ is much closer to the experimental graph, and the error of approximation is ca. 3% (compared to 10% in case of approximation with $T=0.030$ s). Indeed, the values of T obtained previously by other methods are all true, but they correspond with different ranges of the back-pressure.

In order to describe the pressure-dependence of the time constant, the function $T = f(p_k)$ could be linearized and be written in the form of $y=ax+b$. In the case of Fig. 13, the function appears as follows:

$$T = -0.23p_k + 56.28. \tag{11}$$

Such form of the function is very practical, because in an industrial application the operator can easily put the required working back-pressure p_k in kPa and know what the corresponding value of time constant T in milliseconds is. Table 1 presents such functions for several air gauges with measuring nozzle $d_p=1.2$ mm, but with different inlet nozzles d_w and measuring chambers V_k . The formulas cover the linear area of the functions of $p_k=f(s)$, which is for gauges #1 and #2 from 117 kPa up to 142 kPa, and for gauges #3 and #4 from 73 kPa up to 138 kPa. Additionally, the time constant obtained from a sine input response T_{sin} is given for each air gauge.

The sets no. 1 and 2 are high-sensitivity air gauges with a multiplication of 0.88 kPa/ μ m. Their time constants are very different for falling and rising pressure. In fact, the functions $T=f(p_k)$ for different measuring chambers are closer to one another than functions for falling and rising pressure for the same chamber, even though the chamber volumes differ ten times. In case of low-sensitivity air gauges (sets no. 3 and 4 with multiplication of 0.15 kPa/ μ m), the differences between T of falling and rising back-pressure are not too large. Generally, the declination coefficient of the function $T=f(p_k)$ is larger for rising pressures, and it is always greater for larger chambers.

Table 1. The functions $T=f(p_k)$ for several chosen air gauges.

#	d_p [mm]	d_w [mm]	V_k [cm ³]	$T(t)$ - falling p_k [kPa]	$T(t)$ - rising p_k [kPa]	T_{sine} [ms]
1.	1.200	0.625	0.402	$T = -0.025p_k + 5.684$	$T = -0.189p_k + 42.254$	9
2.	1.200	0.625	3.921	$T = -0.080p_k + 13.883$	$T = -0.261p_k + 45.160$	20
3.	1.200	1.200	0.402	$T = -0.010p_k + 3.225$	$T = -0.009p_k + 3.198$	2
4.	1.200	1.200	3.921	$T = -0.026p_k + 8.661$	$T = -0.030p_k + 10.240$	5

6. Practical recommendations

Air gauges are commonly used for in-process measurement, where they measure the changing-in-time dimensions. Basically, the measured dimension is going down, as shown in Fig.14, as the cutting tool is working. In a typical non-contact air gauge, a smaller dimension corresponds to a wider slot width s , and in consequence, with smaller back-pressure p_k , as it is seen in static characteristics (Fig. 15). In the beginning of the cutting process, the workpiece has its largest diameter, which results in the smallest slot s_1 . At the end of the process, the slot goes closer to the maximal value s_3 within the proportional area of the air gauge static characteristics. Hence, in most practical applications with unsteady states, one deals with falling back-pressure in the measuring chamber of the air gauge.

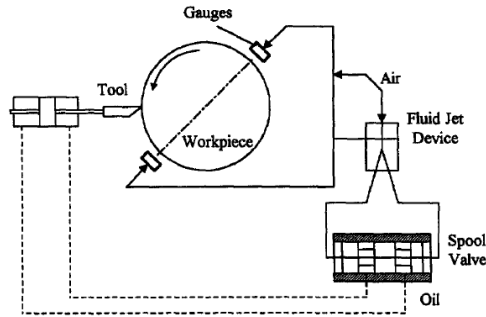

Fig. 14. In-process measurement with hydraulic correction of the cutting tool position [21].

When determining the response time of the air gauge, it seems natural to point out the average value of the time constant. However, in applications like the one presented in Fig. 14, the most responsible part of the measurement process is performed when the dimensions are smallest, *i.e.* close to the largest slot width s_3 . Thus, since it is known that the time constant is the greatest in this very range of the corresponding back-pressures, the projected air gauge should be oriented on the best functionality in this area. Moreover, in such application only the response time for falling pressure is of extreme interest to the operator.

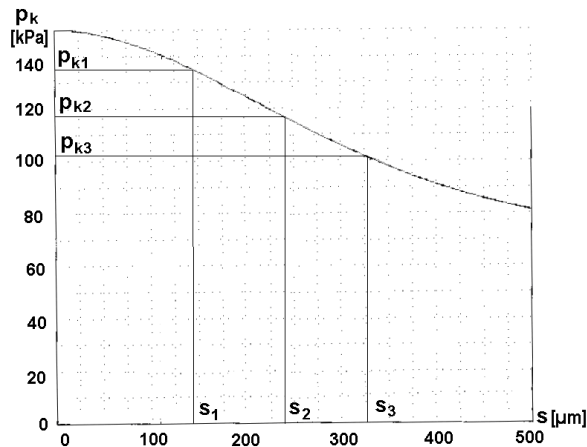

Fig. 15. Example of static characteristics of the air gauge.

That is not the case in other applications like roundness or profile measurement with air gauge. Here, the dynamic calibration with sine input provides better results than the step response analysis, because typical step changes of dimensions rather do not appear in such measurements. The time constant obtained from the amplitude-frequency analysis described in [8] corresponds with real conditions of the air gauge work.

7. Conclusions

The dynamical characteristics of an air gauge should be examined, and measures undertaken to minimize their influence on the measurement results. In many industrial applications, the measured value is time-dependent, and a dynamic error is inevitable.

In order to analyze the step response of the air gauges designed to work in dynamic conditions, an investigations set was built and its inaccuracy of step input generation underwent an analysis. As a result, the difference between the obtained quasi-trapezoidal step response and the simulated one was ca. 3%.

The investigations performed with the air gauges proved that the time constant is dependent on actual back-pressure and is changing during the setting time. The function $T=f(p_k)$ is almost linear and its declination depends on the sensitivity of the air gauge and on the volume of the measuring chamber.

In industrial applications, before the metrological analysis of time response of the air gauge, its real work conditions should be taken into consideration. In case of in-process control, when the back-pressure falls during the measurement process, the step response for falling pressure should be analyzed, especially for its smaller values. On the other hand, when a profile or roundness is to be measured, rather the sine function response should be analyzed.

Acknowledgements

This work was supported by the Ministry of Science and Higher Education, Poland.

References

- [1] R. Hennessy: "Use air to improve measurements; manufacturers turn to air gaging for high-resolution measurements". *Quality Magazine*, May 2005, pp. 30-33.
- [2] I. Menzies, P. Koshy: "In-process detection of surface porosity in machined castings". *International Journal of Machine Tools & Manufacture*, no. 49, 2009, pp. 530-535.
- [3] Y.H. Wang *et al.*: "An Automatic Sorting System Based on Pneumatic Measurement". *Key Engineering Materials*, vol. 295-296, 2005, pp. 563-568.
- [4] E. Urban, D. Urban: "Beitrag zur Berechnung des Zeitverhaltens pneumatischer Hochdruckmessverfahren". *Feingerätetechnik* 15. Jg., Heft 3, 1966, pp. 126-131.
- [5] A. Zelczak: "Pneumatic dimensional measurements". Wydawnictwa Komunikacji i Łączności, Warszawa 2002. (in Polish)
- [6] M. Rucki, B. Barisic, G. Varga: "Air Gauges as a Part of the Dimensional Inspection Systems". *Measurement*, vol. 43, issue 1, January 2010, pp. 83-91.
- [7] *Piezoresistive Silicon Pressure Sensors*. SenSpecial GmbH&Co.KG
- [8] M. Rucki, B. Barisic: "Response Time Of Air Gauges with Different Volumes of the Measuring Chambers". *Metrol. Meas. Syst.*, vol. XVI, no. 2, 2009, pp. 289-298.
- [9] L. Finkelstein: "Reflections on a century of measurement science as an academic discipline". *Metrol. Meas. Syst.*, vol. XIV, no. 4, 2007, pp. 635-638.

- [10] M. Rucki, Cz.J. Jermak, Z. Jaskólska: "Investigations on the Improvement of the Air Gauges". *Printed scientific works*, Kharkov Technical University, Kharkov, Ukraine, no. 1(16), 2008, pp. 247-256.
- [11] *Everything that counts*. Nieberding GmbH, 2008.
- [12] *Handbook of Measuring System Design*. ed. by P.H. Sydenham & R. Thorn, vol. 1, Wiley, London, 2005.
- [13] Th.G. Beckwith, R.D. Marangoni, J.H. Lienhard: *Mechanical Measurements*. 6th edition, Pearson Education Inc., Upper Saddle River 2007.
- [14] E. Layer: "Non-standard input signals for the calibration and optimisation of the measuring systems". *Measurement*, no. 34, 2003, pp. 179-186.
- [15] Ch.O. Lahoucine, A. Khellaf: "Dynamic characterization of a thermocouple in a fluid crossflow". *Sensors and Actuators A*, no. 119, 2005, pp. 48-56.
- [16] M. Rucki: "Step Response of the Air Gauge". *Metrol. Meas. Syst.*, vol. XIV, no. 3, 2007, pp. 429-436.
- [17] Cz.J. Jermak, M. Rucki: "Evaluation of the time responses of air gauges in industrial applications". *Proceedings of the 13th National & 4th International Conference: Metrology in Production Engineering*, Sep. 23-25, 2009, Poznań – Żerków, pp. 207-212.
- [18] Ph. De Larminat, Y. Thomas: "Automatics – linear systems. Identification". vol. 2, WNT, Warszawa, 1983. (in Polish)
- [19] W. Findeisen: *Technics of automatic control*. PWN, Warszawa, 1978. (in Polish)
- [20] W. Koscielny, C. Wozniak: "Experimental evaluation of flow models in pneumatic resistances". *Proceedings of the Conference PNEUMA'95*, Koszalin – Kielce, 1995, pp. 83-92.
- [21] T. Yandayan, M. Burdekin: "In-process dimensional measurement and control of workpiece accuracy." *International Journal of Machine Tools and Manufacture*, vol. 37, issue 10, Oct.1997, pp. 1423-1439.